

NEW!

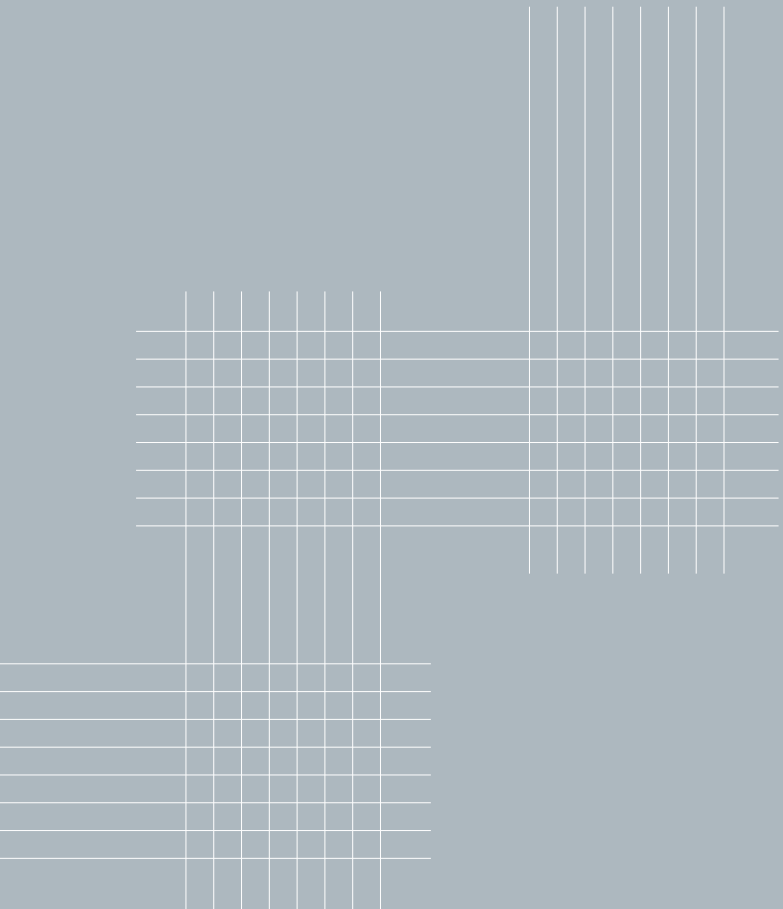

centor

STE Eco-Screen™ for any door or window type



CONTENTS

Screening Problems Solved	1
Considered Design	2
Built Tough and Tested	5
Projection Screen	6
Architect Interviews	7
Architectural Detail	9
S1E with Folding System	9
Brick Veneer	11
Concrete Block	13
Timber Cladding	15
S1E with Sliding System	17
Brick Veneer	19
Concrete Block	21
Timber Cladding	23



SCREENING PROBLEMS SOLVED

S1E Eco-Screen™ max frame size	
Single System or Multi-function System	12'9" (W) x 10'6" (H)
Double System	24'10" (W) x 10'6" (H)

The S1E Eco-Screen™ from Centor Architectural is a world-first product providing retractable insect screening and solar control with fingertip operation. This product is the evolution of Centor's award-winning S1 Insect Screen.

S1E allows homeowners to have complete control of their living environment. Used singly or paired together S1E is ready for use whatever the season or time of day. S1E retracts horizontally and discreetly into its frame when not in use – a revolutionary solution for those who refuse to compromise on style.

The S1E Eco-Screen™ promotes an eco-friendly lifestyle by offering chemical-free insect protection, solar control and thermal insulation; converting a single-glaze opening to double-glaze performance.

On openings up to 12'9" wide either single or multi-function options are available.

Where a single function is required choose from insect screen or sun filter fabrics. For a multi-function option select both fabric classes to create a two-in-one screening solution.

Single Function System

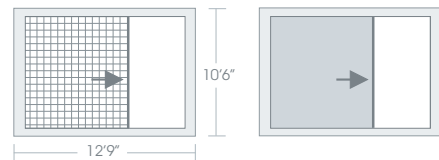

option 1 – screen from right or left
option 2 – blind from right or left

Double System

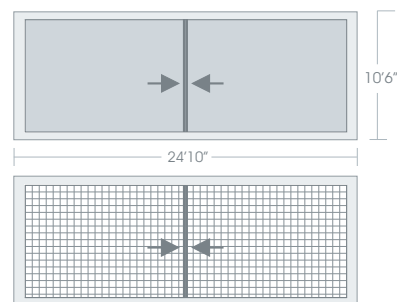

option 1 – screen from right and left
option 2 – blind from right and left

Multi-function System

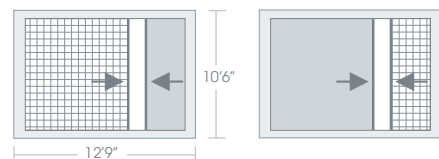

option 1 – screen from right, blind from left
option 2 – screen from left, blind from right

CENTOR INNOVATIONS ENSURE S1E FUNCTIONS SIMPLY AND SMOOTHLY



CONSIDERED DESIGN

Create a multi-function system using sun filter and insect fabrics to provide solar control in the mornings and prevent insects entering the home in the evenings

For openings wider than 12'9" and up to 24'10" wide choose one fabric class only, either mesh or blind for a double system.

The considered design of the S1E Eco-Screen™ complements any large opening. Available in a clear anodized finish, custom colors and real wood veneers, it's mechanisms are concealed within the frame so screen and frame become an integrated unit.

A range of Centor innovations ensure the whole package functions simply and smoothly.

Load Balancing Technology™

Load Balancing Technology (LBT™) (patent pending) allows for the effortless fingertip control synonymous with Centor products. With no crude spring-loading to fight against, the screen's lead-stile remains firmly in any chosen position until further pressure is applied. Load-balancing also means far greater tension across the screen or blind, eliminating any tendency for sag.

Tight Technology™

Tight Technology™ manufacturing techniques ensure control of the horizontal edges of the screen so they remain straight and tight across the widest spans.

Shock Absorption

In the majority of cases the shock absorption mechanism prevents system damage by redirecting impact away from the screen.

Self-Feeding Mechanism

Should winds blow the screen out of the top or bottom channels the fabric will self-feed back onto the roll.

Real Wood Veneer

Select from Mahogany, VG Douglas Fir or Oak.

Clear Anodized

A tough and hard, corrosion resistant metallic finish.

Paint

Select from a wide range of AAMA approved paint finishes.

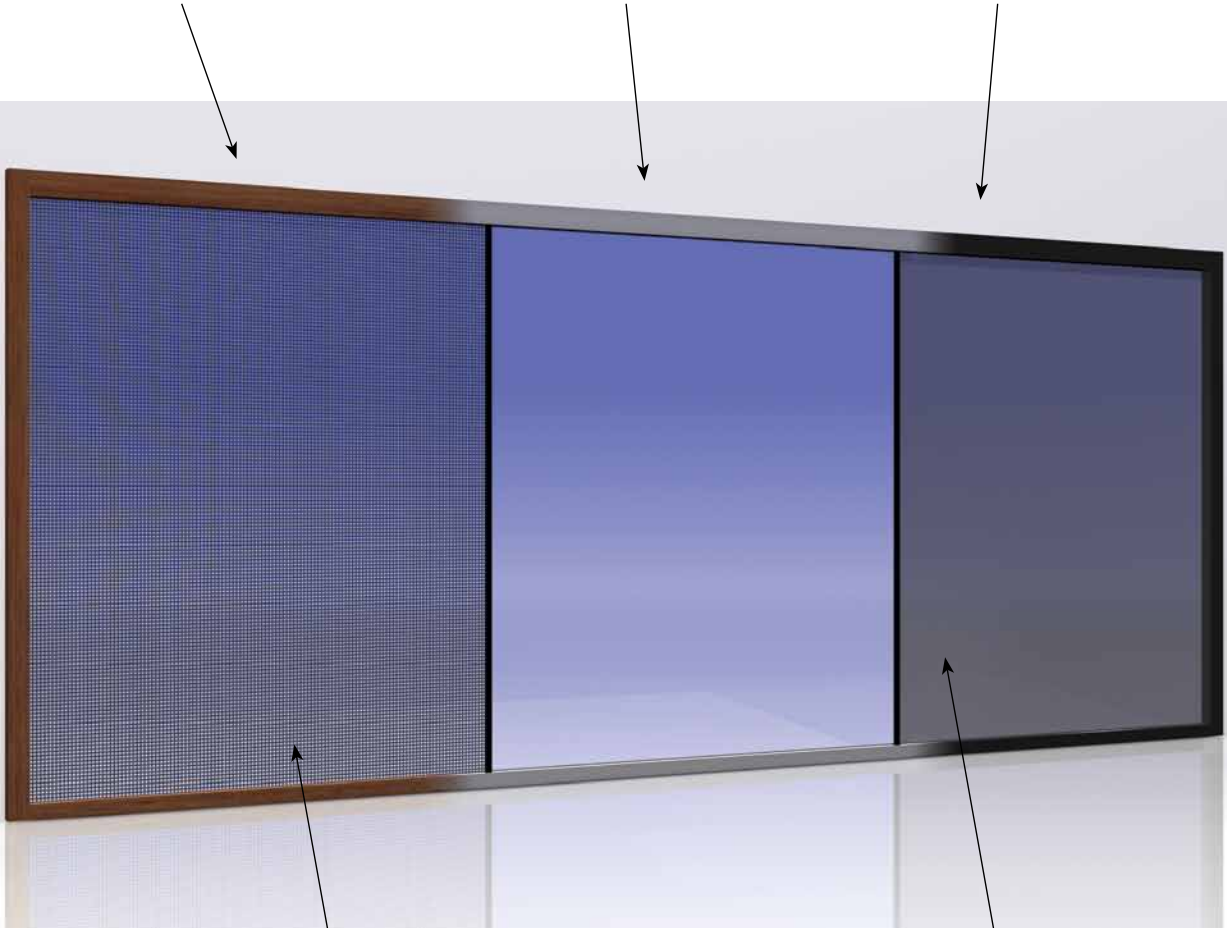

Insect Screen

Insect Screen made from hard wearing PVC coated Polyester.

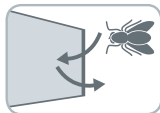

insect protection

Blind

Sun filter fabric made from Fiberglass/PVC is available in a range of colors.

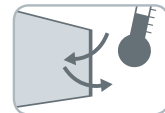

control heat gain & loss

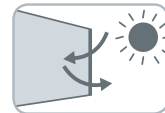

UV protection



projection screen

AVAILABLE IN CUSTOM COLORS & REAL WOOD VENEER FINISHES

USE WITH ANY DOOR OR WINDOW

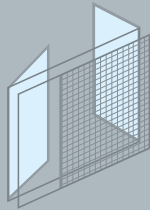

French Doors

S1E is an ideal solution for screening French doors. Use the screen and blind combination to solve two problems with one system.

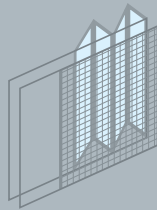

Bifold Doors

The Centor name remains synonymous with bifold door openings and S1E is ideally suited to use with the full range of Centor bifold systems.

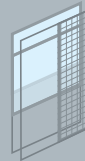

Windows

Use S1E with banks of casement, double hung and bifold windows to complement the widest variety of homes and commercial premises.

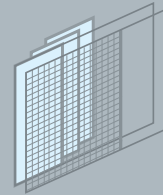

Sliding Doors

Large sliding doors and stacker doors are an ideal application for S1E. Very large openings can be effortlessly accommodated by an S1E double unit.

TESTING

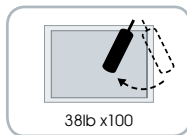

38lb x100

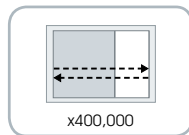

x400,000

FABRIC CHOICES

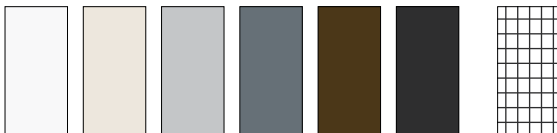

Sun Filter

Insect Screen

PAINT COLORS



For a full range of paint colors visit www.centorarchitectural.com

Swatches shown are a representation of color only and may not match actual fabric/paint. Please contact Centor Sales and Customer Service for samples.

CORROSION & IMPACT TESTED SIMULATING REAL LIFE USE



BUILT TOUGH AND TESTED

In developing the S1E, Centor's designers have catered for anything that modern life might throw at this sturdy product.

Materials

S1E is manufactured in a combination of aluminum, stainless steel, brass and reinforced engineering polymers. The blind is available in sun filter fabric. The tough PVC-coated polyester screen mesh is hardwearing and resistant to damage caused by pets and children.

Testing

The S1E Eco-Screen™ has undergone cyclic testing to 400,000 operations in a laboratory and extensively exposed to dust, mud, sand and corrosive atmosphere to ensure it is a product for the real world. It has withstood impact testing with a 38lb punching bag 100 times and considerable pushing, poking and prodding to simulate real life usage.

Screen Maintenance

The insect screen material should be cleaned with a soft brush or a damp soft cloth, while the sun filter fabric should be cleaned with warm soapy water and a soft cloth.

Tracking should be regularly cleaned to prevent the build-up of dirt and debris. A vacuum cleaner fitted with a nozzle is effective.

Operating mechanisms are fully self contained and do not require maintenance other than keeping clear of dirt and debris.

Warranty

Centor Architectural offers a 5 year limited warranty on its S1E Eco-Screen™.



SOLAR CONTROL BLIND DOUBLES AS A PROJECTION SCREEN



PROJECTION SCREEN

The S1E solar control blind doubles as a projection screen for either indoor or outdoor viewing. Watch your favorite movie outdoors on a warm summer night, or enjoy your favorite sport with friends on the 'big screen'.

Centor's Load Balancing Technology™ enables the blind to be left partially open, allowing visitors to pass through the door way without the hassle of opening and closing the blind.

WONDERFUL SCREENING IS MORE IMPORTANT THAN WONDERFUL DOORS

James Russell, James Russell Architect



James Russell
James Russell Architect

Leading architect James Russell's private home won major awards and was featured in leading Australian and international magazines, but it wasn't quite finished until he made the final adjustments three years after the home was completed.

The inner-Brisbane home, created between two heritage-listed buildings on what was once an old car park, is full of unique touches including a central open air grassed courtyard surrounded by rooms and living space.

But the beautiful home was attracting some unwelcome visitors – mosquitoes.

"When I designed the house there was nothing available that screened the opening to the courtyard without being invasive. It was important that nothing obstructed the relationship between the house and the open outdoor space." James said.

The availability of the screening system from Centor Architectural three years later excited James so much he reemployed the builders to make some adjustments.

As they can be fitted to any existing door or window, James was able to design them into his existing home with minimal adjustments made to the foundations.

"Builders removed small sections of timber and flooring to install the tracks and storage space for the screens.

"As there are no panels or mullions in the screens there is nothing to impair the view or break up the scene."

James feels the screens are almost unnoticeable. "After you've looked into the courtyard there is no memory of the screens you have just looked through. Even inside, we feel we are living in a veranda space," James said.

James' screens are 14.27' wide and 7.87' high and are located at both ends of his courtyard, protecting the kitchen area at one end and the living space at the other.

"Because we didn't need the screens for security, only comfort, we hope to leave them open for nine months of the year."

With the Queensland summer months being a favorite for mosquitoes after dark, James finds the screen invaluable in protecting his family when needed.

The system is also easy for James' young family to use. "It slides effortlessly with one finger allowing you to control the house and still enjoy the breezes, fresh air and outside noises."

"There is a trend to use big doors and this creates a need for security and the weather to be managed in another way, so that the doors aren't always being opened and closed.

"Wonderful screening is more important than wonderful doors. Prior to the arrival of the Centor screen, I couldn't find nice clean screening that also kept the house open."

James' home won the Robin Dods Award for Residential Architecture at the Queensland Architecture Awards in 2006 and went on to place second nationally. His seven year old business is renowned for designing unique residential homes which blend with Australia's tropical lifestyle.

THE OPTION OF 'LIVING OUTDOORS' IS NOW FULLY PROTECTED

Shawn Godwin, Base Architecture



Shawn Godwin
Base Architecture

Leading architect, and founder and director of Base Architecture, Shawn Godwin, has just installed the new S1E Eco-screen™ from Centor Architectural in his own home and sees enormous potential for the screen and blind system in the home and in buildings he designs.

"This system solves all our problems. We push the blind across to protect us from the early morning sun and open it to enjoy the outdoors.

"The industry has been looking for this sort of system for some time. Blinds have always been an issue for architects ensuring they won't clash with windows when open, or look like some clunky add on. These just disappear. They are brilliant.

"The science and research behind opening and closing the Centor screens and blinds is more sophisticated than anything available.

"The very idea of a screen is that you don't want to see the window or door mechanism. Centor's screens are clean-lined and concealed and aesthetically very pleasing.

"In the Australian climate everyone wants to live outdoors but when we design houses that bring in the outdoors they also bring in unwanted sun, insects and prying eyes.

"Privacy and protection from insects and sun has to date meant changing the whole dynamics of the look and feel of the design. The Centor blind and screen combinations change all that. They allow the building to stay true to its outdoor design.

"The option of living outdoors is now fully protected.

"The traditional media room design is changing and increasingly includes windows. The Centor system not only blocks out the light it becomes an option for a projector screen.

"Without products like the Centor screens and blinds it is hard for some of our designs to get sold to the market. It is clearly the best system around.

"Combined with new glazing options that emit heat, the S1E Eco-screen™ can be explored for full solar reflector benefits.

"This system solves all the problems. The Centor S1E system fits all needs."

ARCHITECTURAL DETAIL / SIE WITH FOLDING SYSTEM

Head Detail

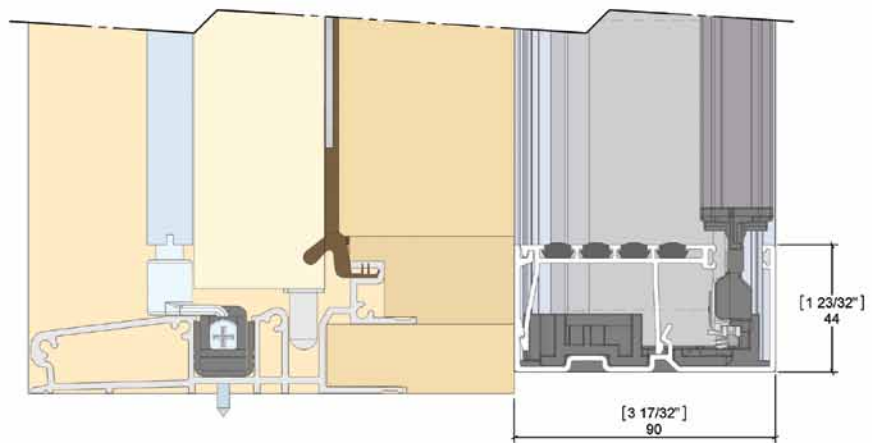
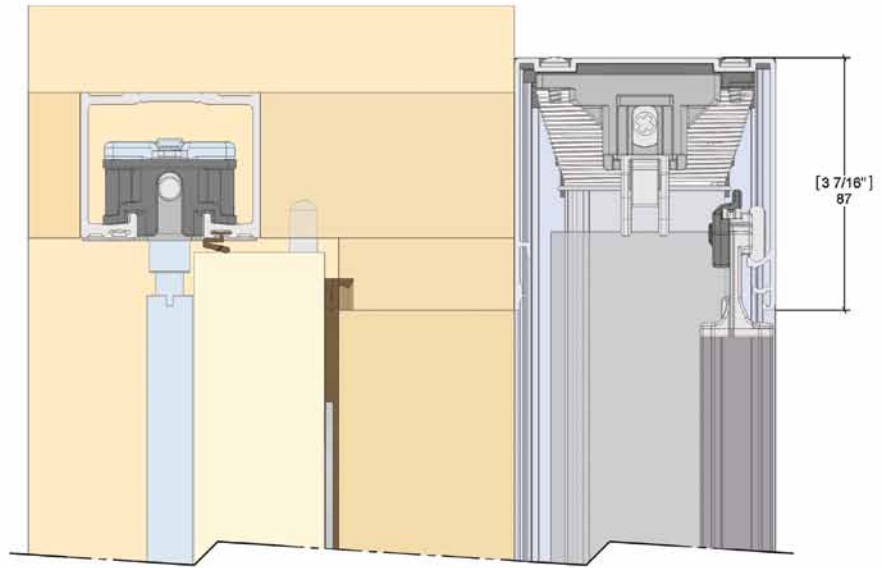

ARCHITECTURAL DETAIL / SIE WITH FOLDING SYSTEM
Jamb Detail

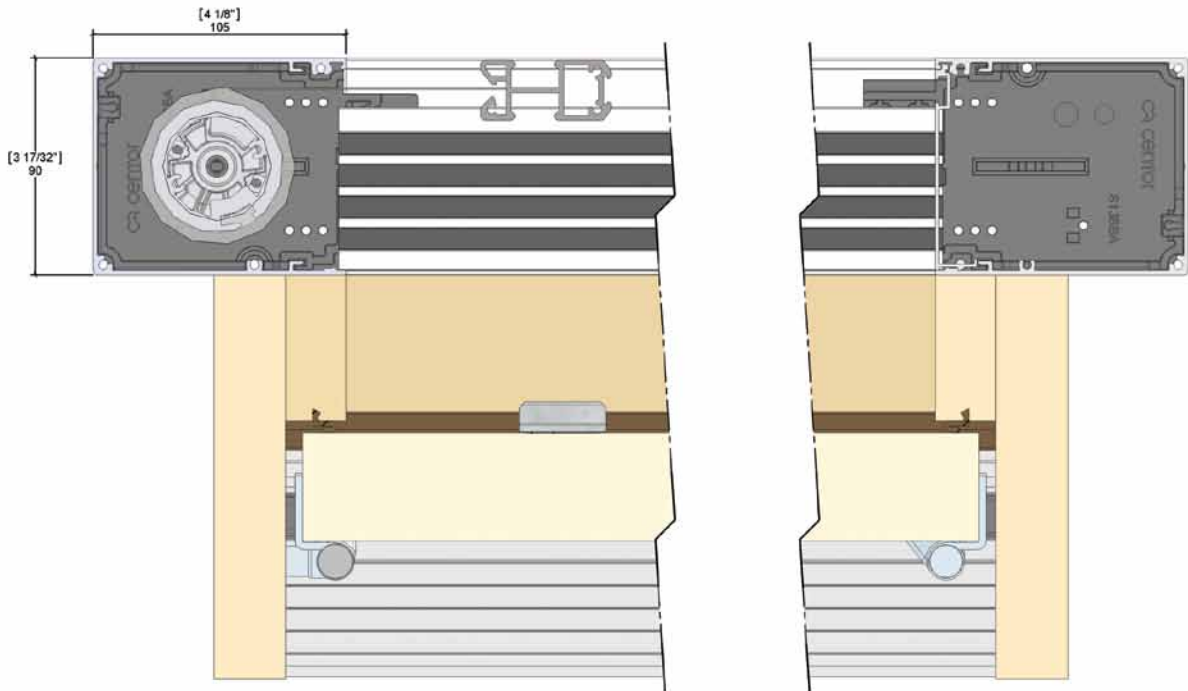

ARCHITECTURAL DETAIL / SIE WITH FOLDING SYSTEM

Brick Veneer – Head

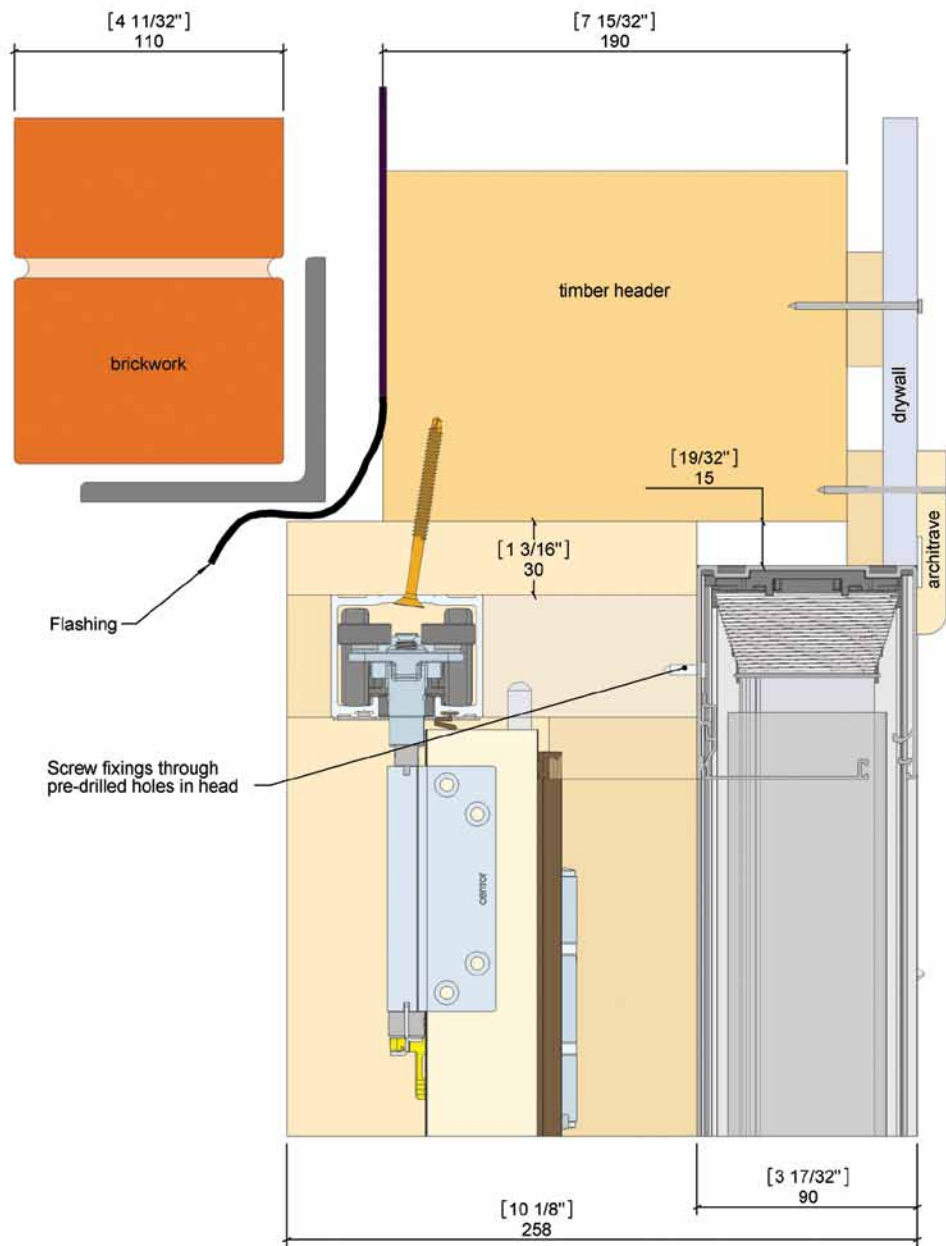

ARCHITECTURAL DETAIL / S1E WITH FOLDING SYSTEM

Brick Veneer – Jamb

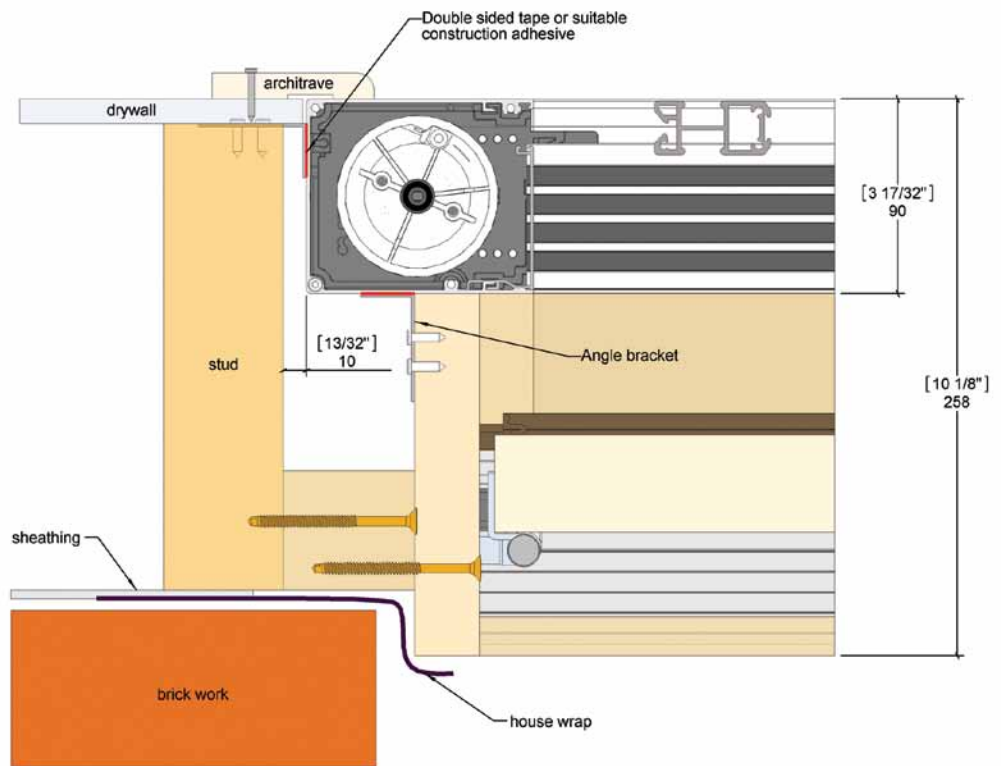

ARCHITECTURAL DETAIL / S1E WITH FOLDING SYSTEM

Brick Veneer – Sill

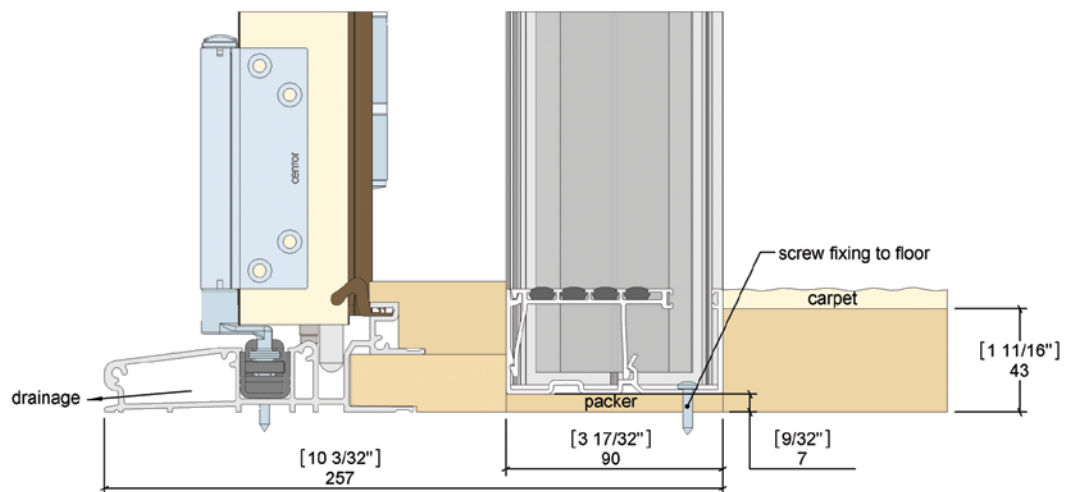

ARCHITECTURAL DETAIL / SIE WITH FOLDING SYSTEM

Concrete Block – Head

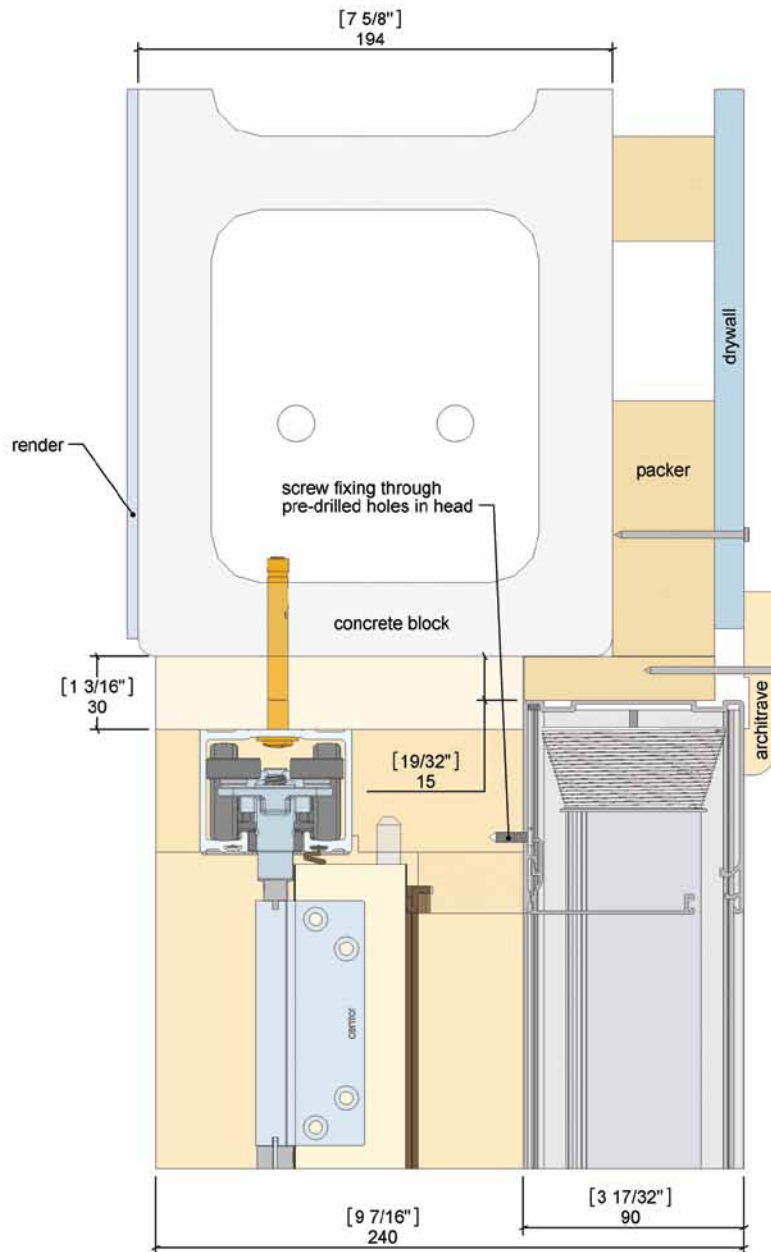

ARCHITECTURAL DETAIL / S1E WITH FOLDING SYSTEM

Concrete Block – Jamb

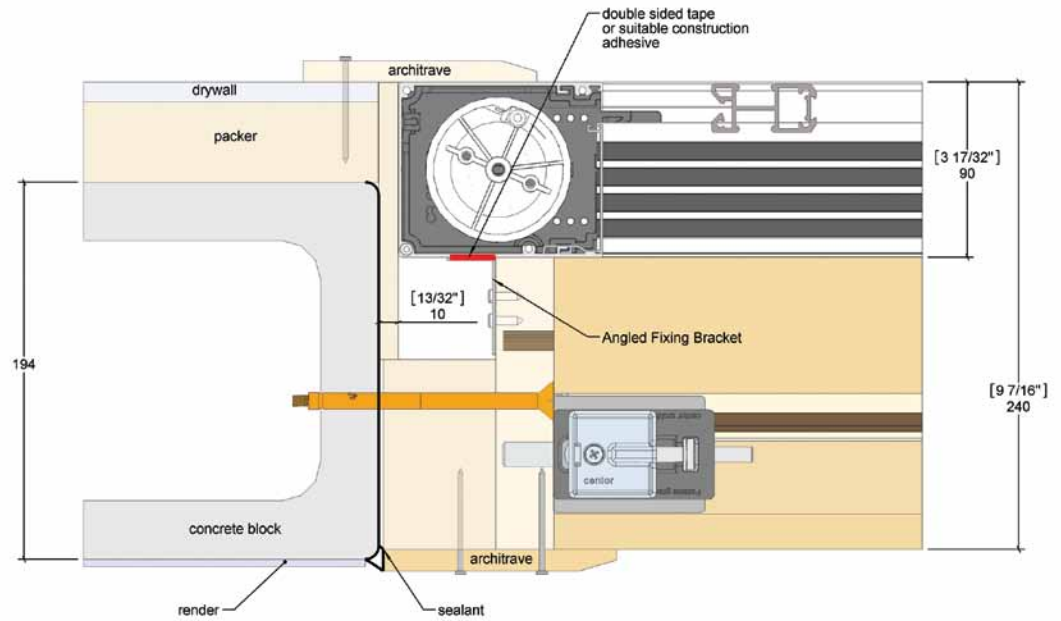

ARCHITECTURAL DETAIL / S1E WITH FOLDING SYSTEM

Concrete Block – Sill

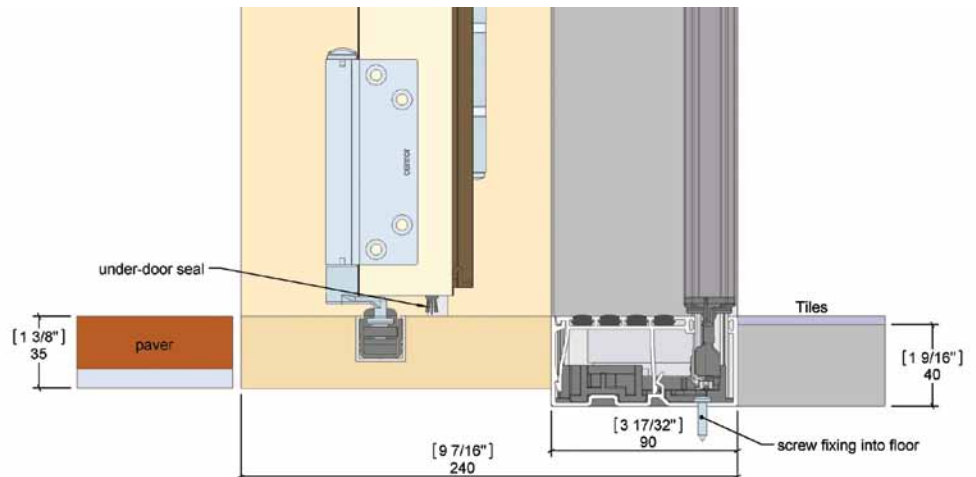

ARCHITECTURAL DETAIL / S1E WITH FOLDING SYSTEM

Timber Cladding – Head

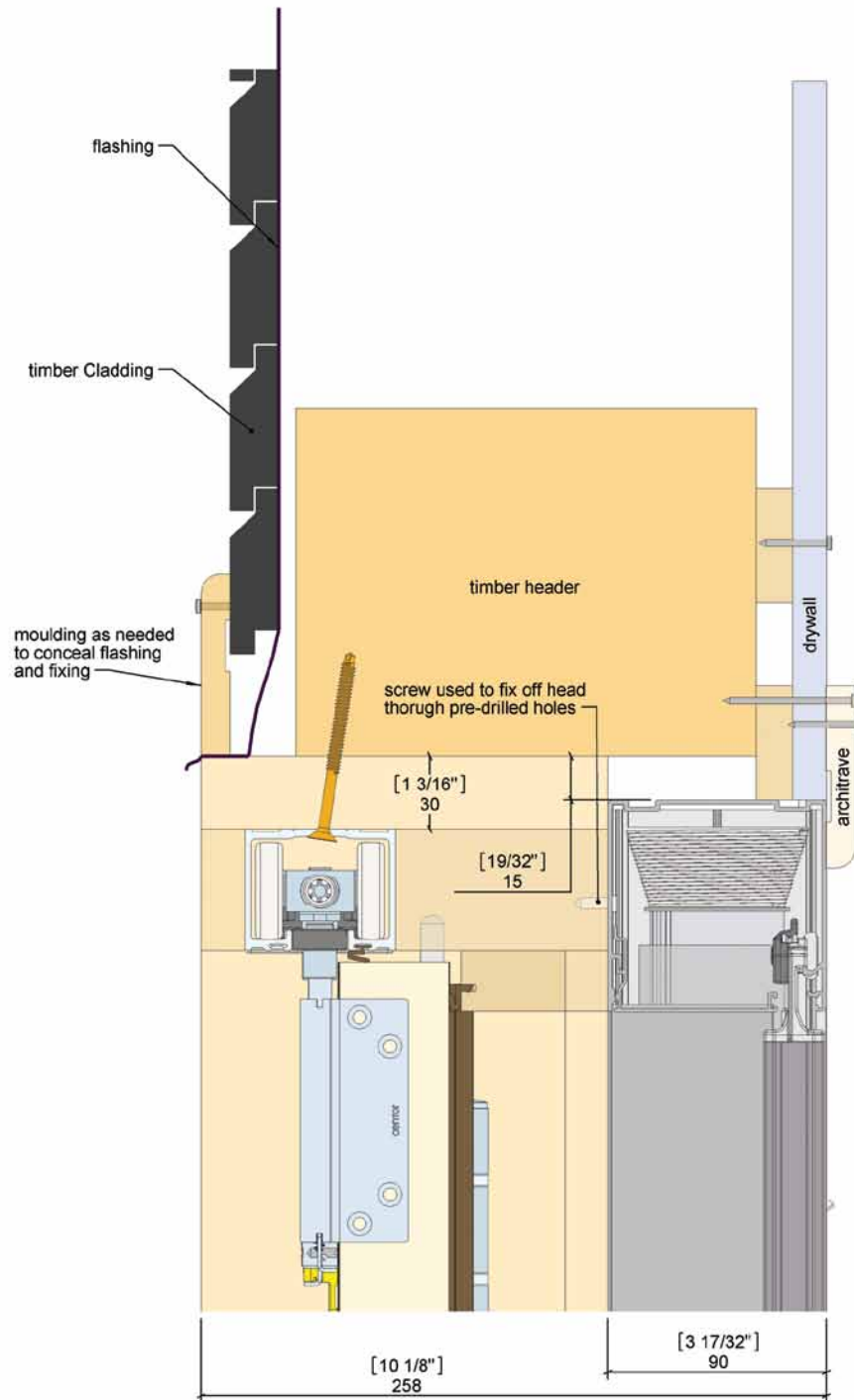

ARCHITECTURAL DETAIL / S1E WITH FOLDING SYSTEM

Timber Cladding – Jamb

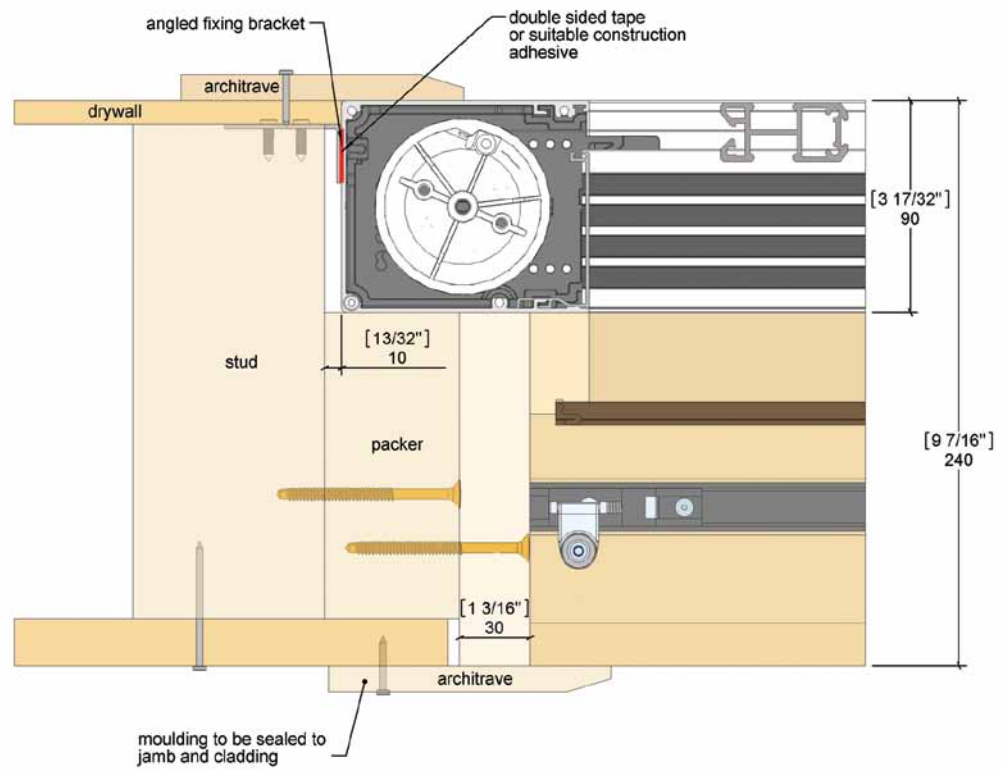

ARCHITECTURAL DETAIL / S1E WITH FOLDING SYSTEM

Timber Cladding – Sill

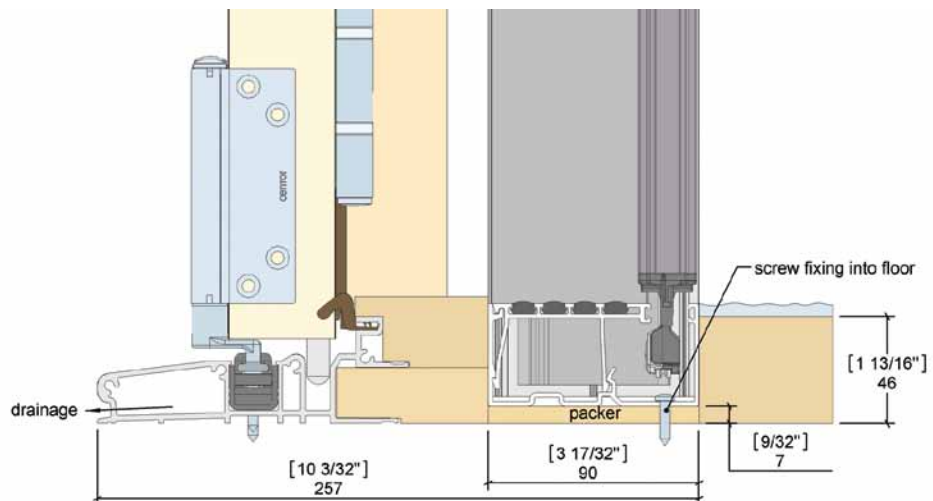

ARCHITECTURAL DETAIL / STE WITH SLIDING SYSTEM
Head Detail

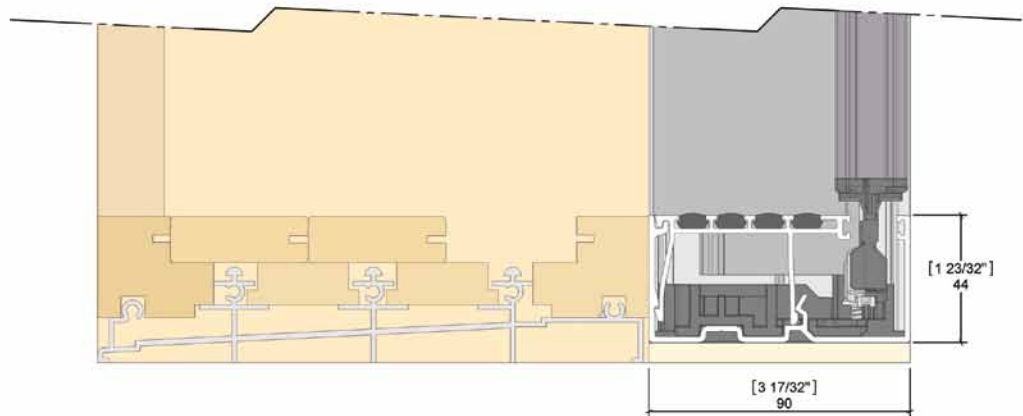
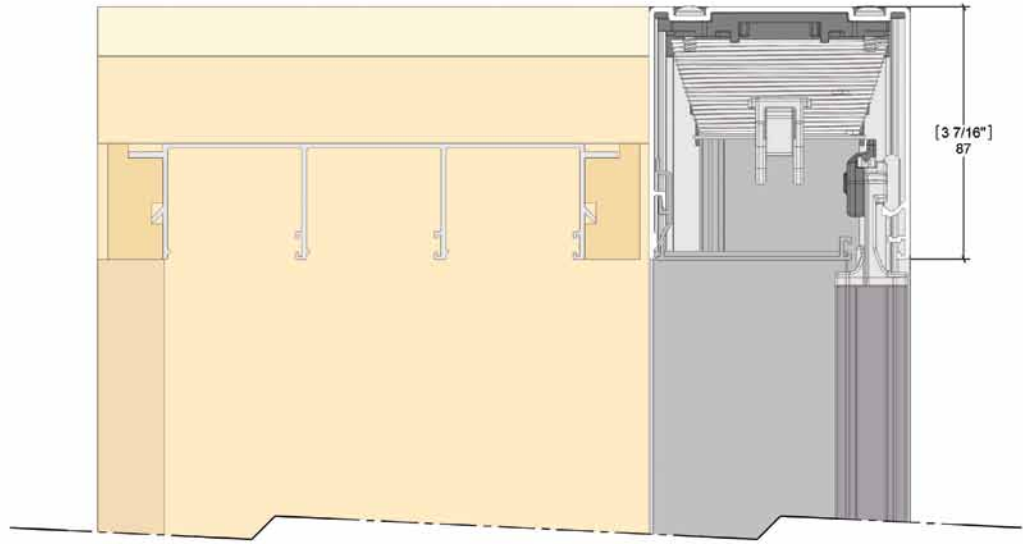

ARCHITECTURAL DETAIL / STE WITH SLIDING SYSTEM
Jamb Detail



ARCHITECTURAL DETAIL / SIE WITH SLIDING SYSTEM
Brick Veneer – Head

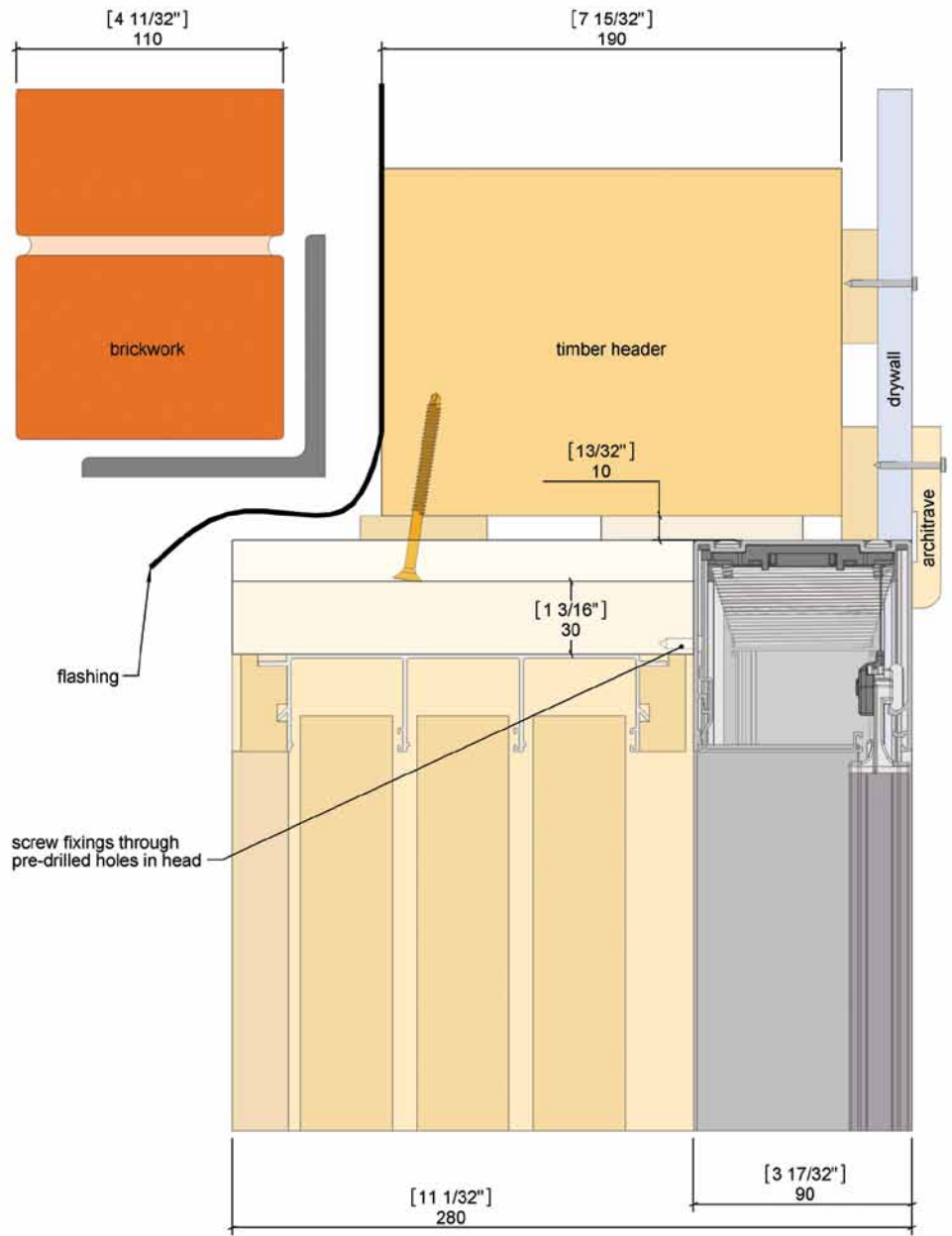

ARCHITECTURAL DETAIL / S1E WITH SLIDING SYSTEM

Brick Veneer – Jamb

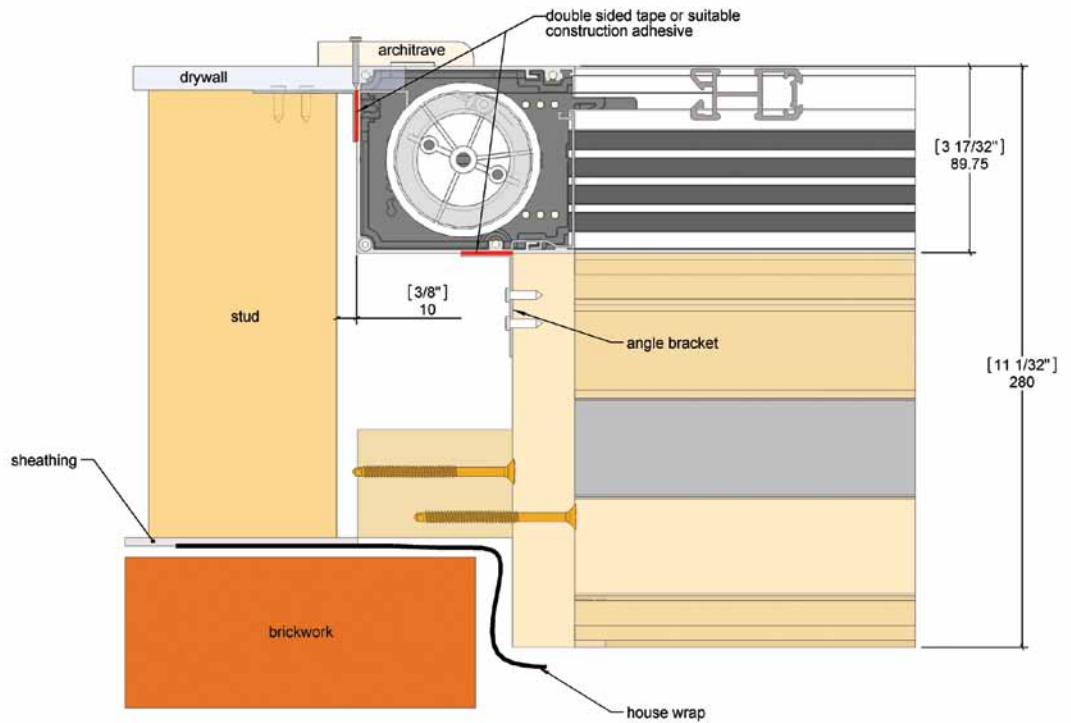

ARCHITECTURAL DETAIL / S1E WITH SLIDING SYSTEM

Brick Veneer – Sill

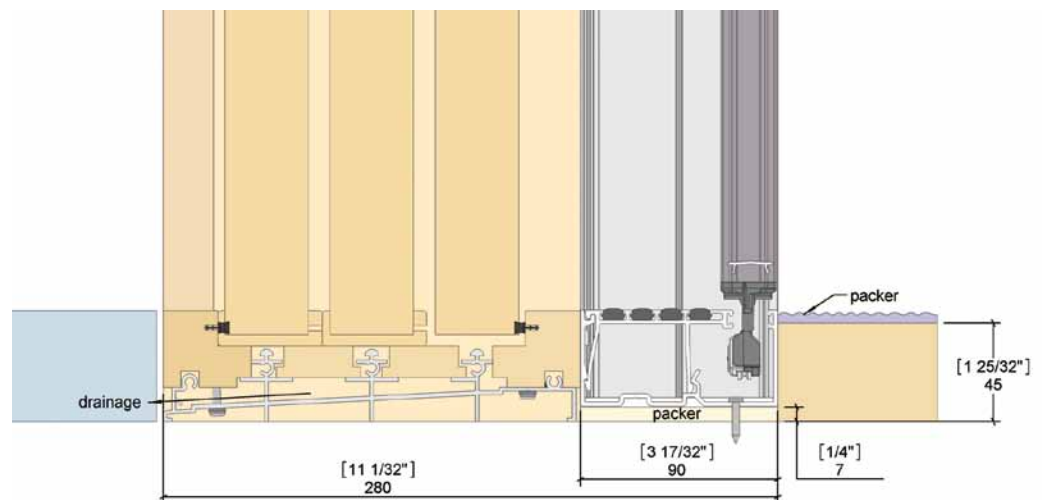

ARCHITECTURAL DETAIL / SIE WITH SLIDING SYSTEM

Concrete Block – Head

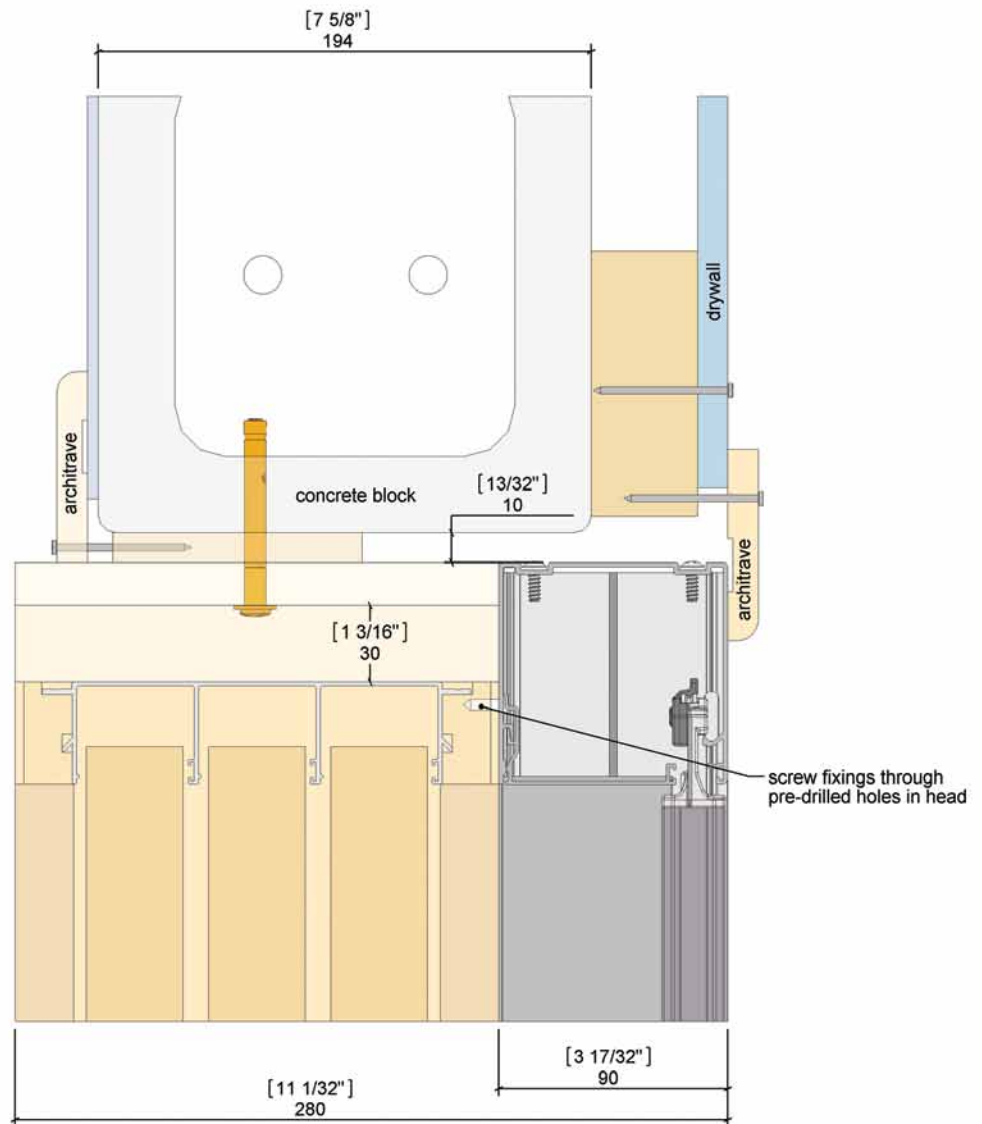

ARCHITECTURAL DETAIL / S1E WITH SLIDING SYSTEM

Concrete Block – Jamb

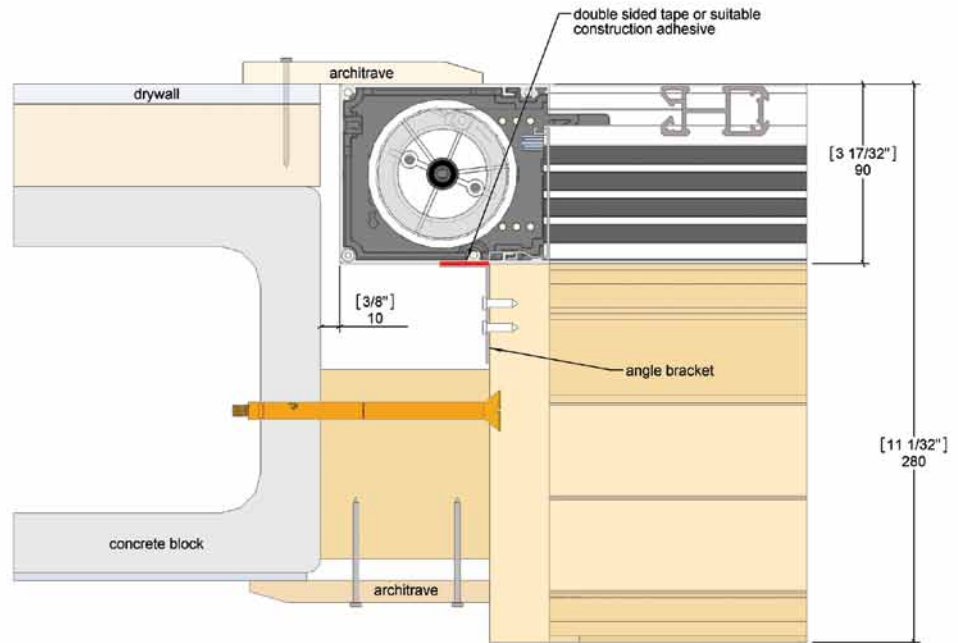

ARCHITECTURAL DETAIL / S1E WITH SLIDING SYSTEM

Concrete Block – Sill

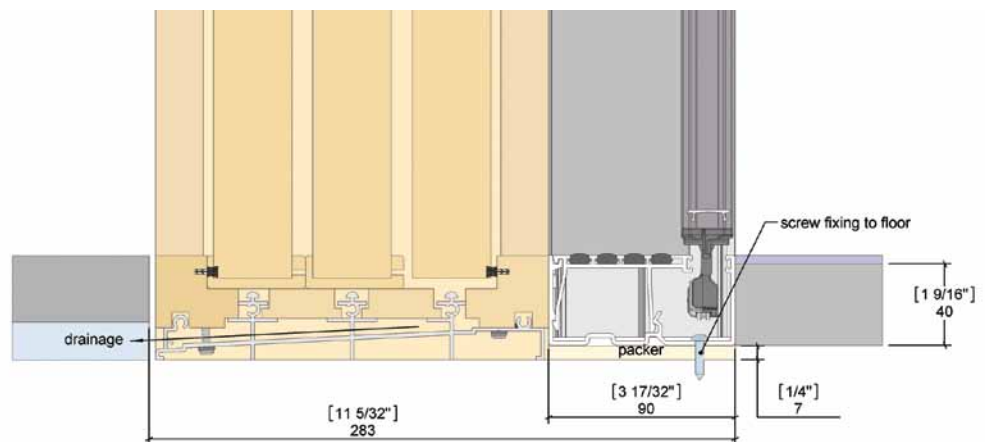

ARCHITECTURAL DETAIL / S1E WITH SLIDING SYSTEM

Timber Cladding – Head

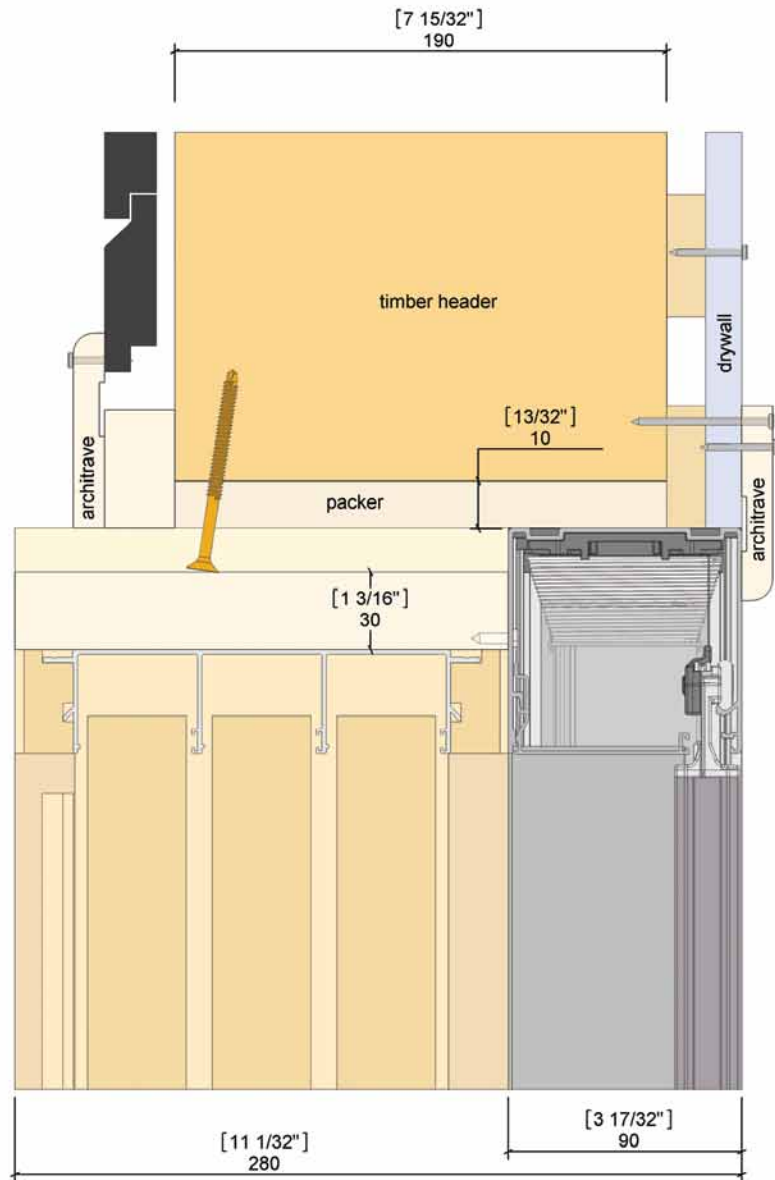

ARCHITECTURAL DETAIL / S1E WITH SLIDING SYSTEM

Timber Cladding – Jamb

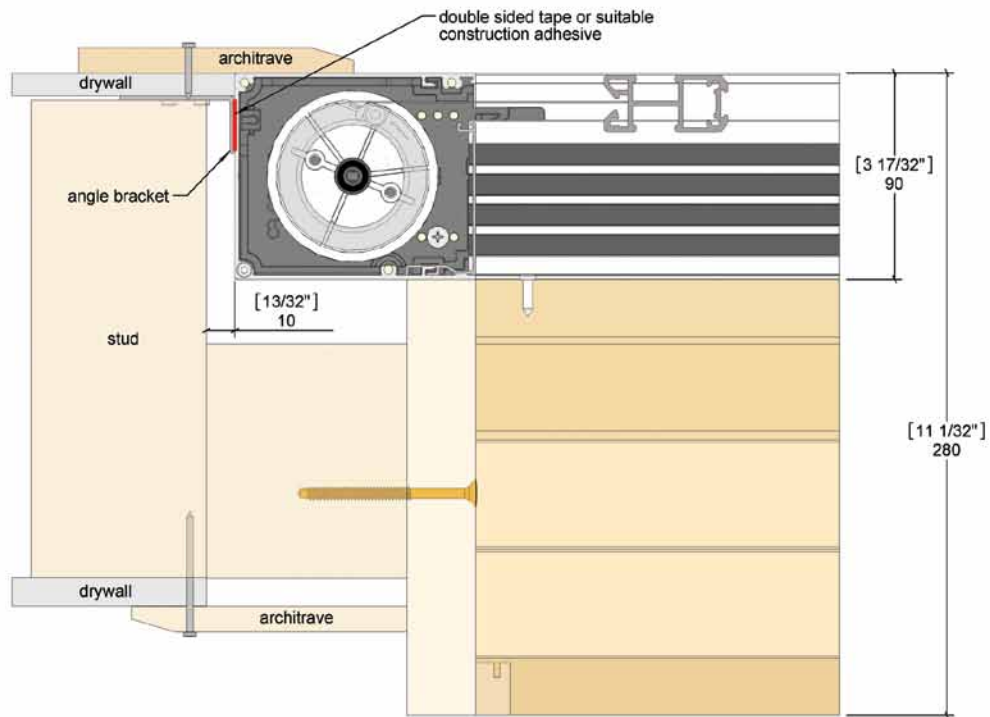

ARCHITECTURAL DETAIL / S1E WITH SLIDING SYSTEM

Timber Cladding – Sill

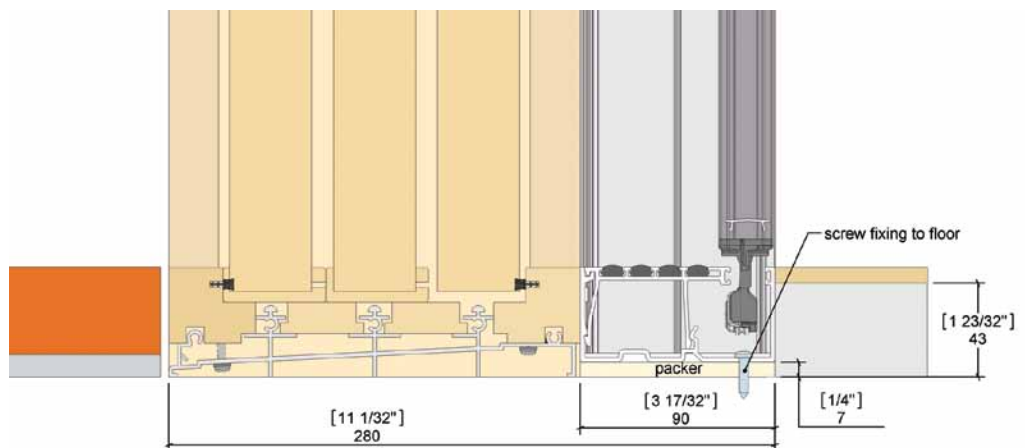

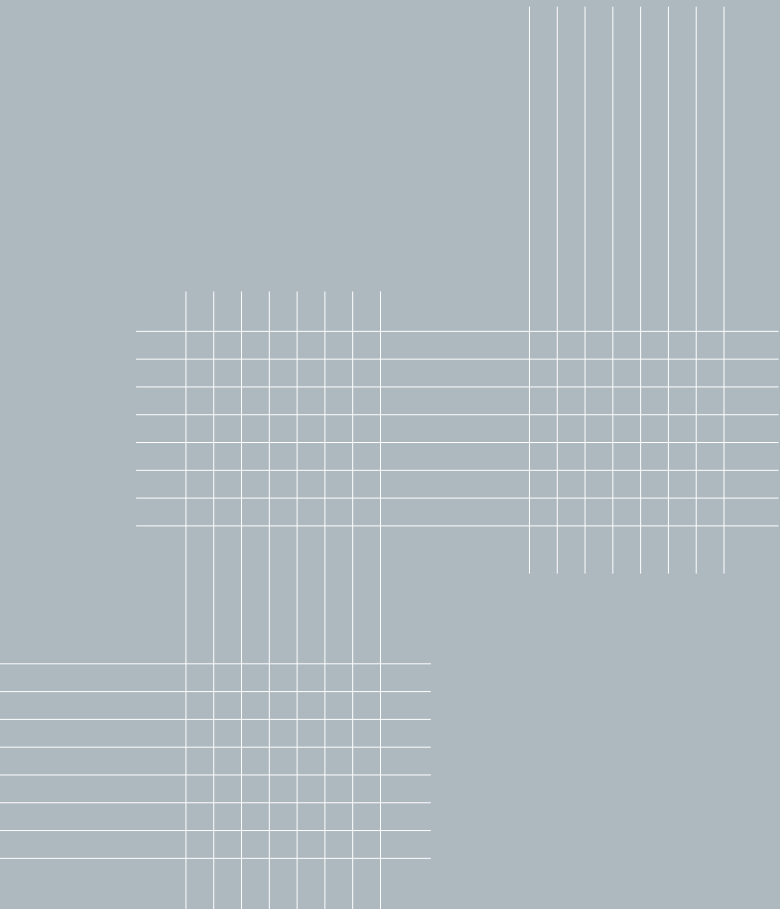

While every effort has been made to ensure the accuracy of the information in this publication, Centor Architectural assume no responsibility for errors or omissions or any consequences of reliance solely on this publication.



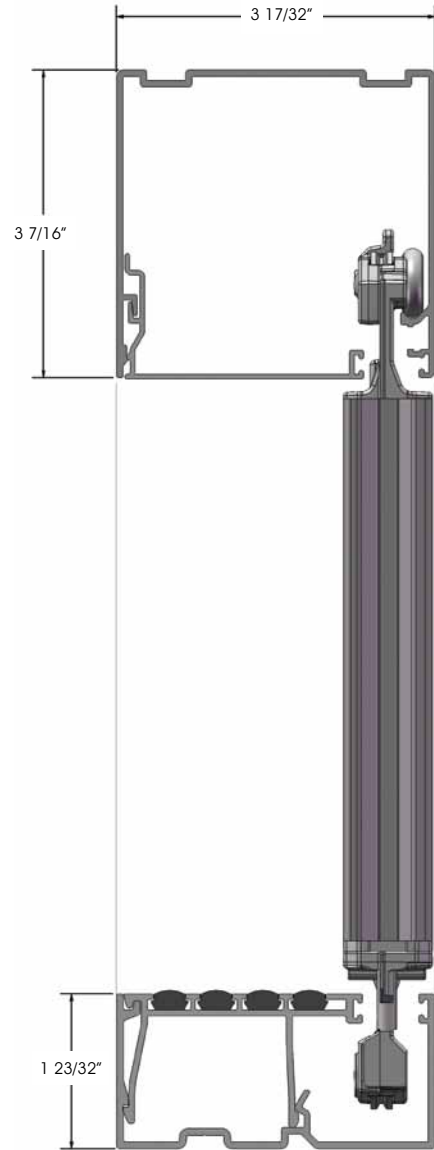
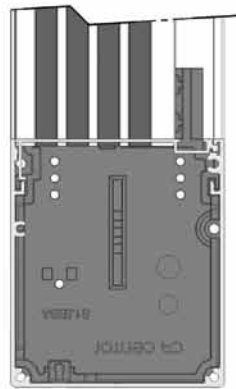
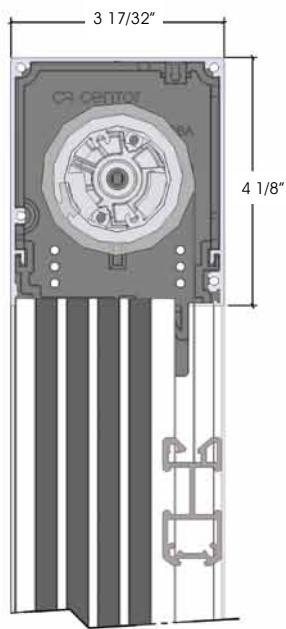

Sectional side view (screen roll omitted in the drawing for clarity)

214-200-030-001